



PAOLINI

GARMENT COMPANY

SHIRT DESIGN BOOK

Collars

Spreads based on a 3" Point Length

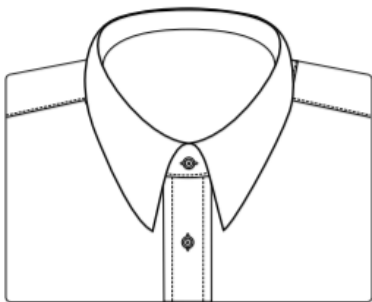

Extra Narrow Point

XNP

2" Spread

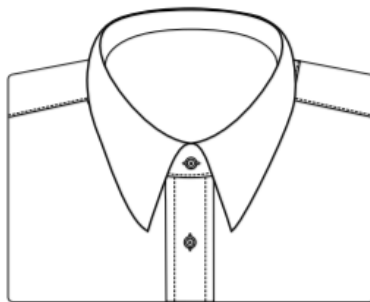

Narrow Point

NP-1

2 1/2" Spread

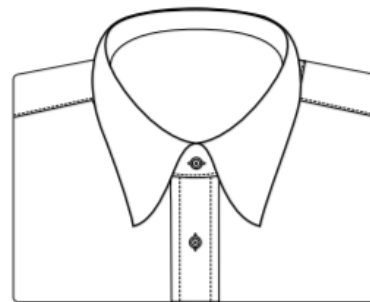

Classic Point

CP-1

3" Spread



Madison Point

MP-1

3 1/2" Spread



Button Down Classic**

BD-1

3" Spread

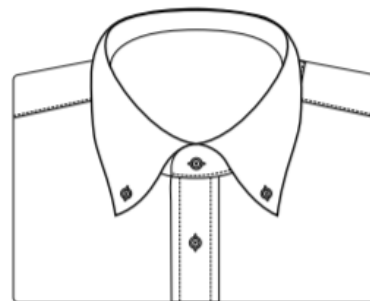

Button Down Madison**

BD-2

3 1/2" Spread

Collars

Spreads based on a 3" Point Length



Hidden Button Down Classic

HB-1

3" Spread



Hidden Button Down Madison*

HB-2

3 1/2" Spread

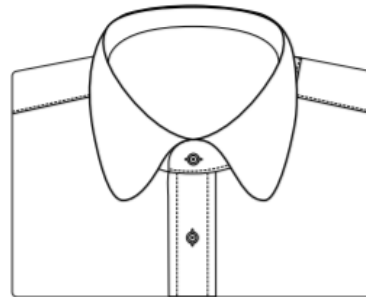

Round Point Madison

RP-1

3 1/2" Spread



Round Button Down Madison*

RB-1

3 1/2" Spread

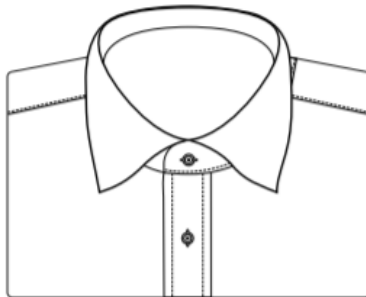

Windsor Spread

WS-1

4" Spread

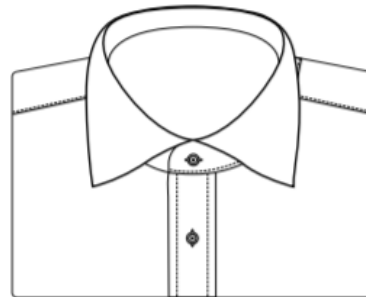

American Spread

AS-1

4 1/2" Spread

Collars

Spreads based on a 3" Point Length

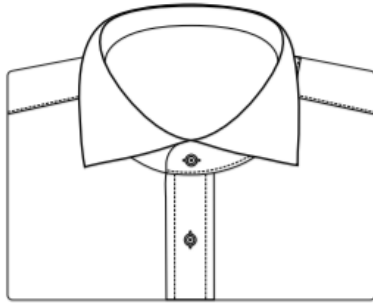

British Spread
BS-1
5" Spread

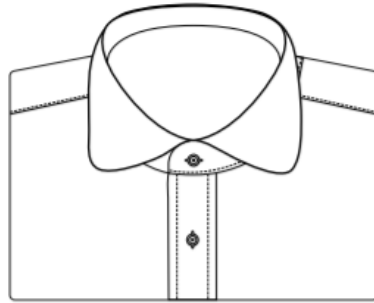

British Round Point Madison
BRP
--

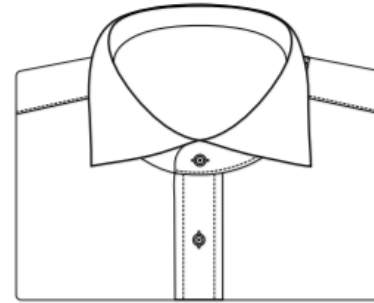

Italian Spread
iS-1
5 1/4" Spread

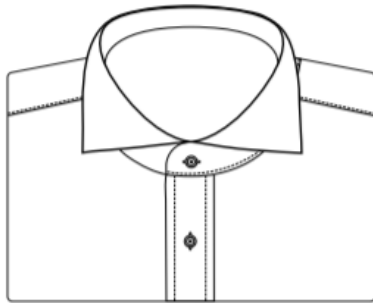

Fashion Spread 1
FS-1
6" Spread

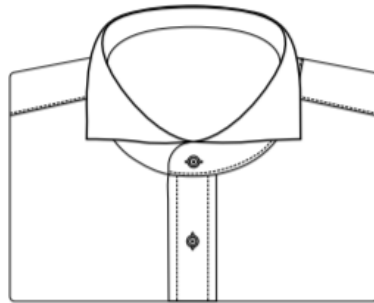

Fashion Spread 2
FS-2
6 1/2" Spread

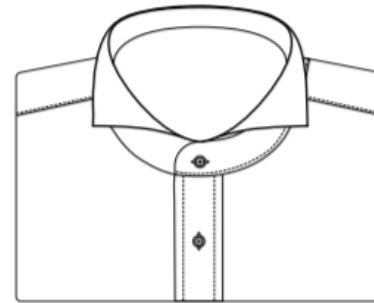

Extreme Cutaway
EC
--

Collars

Spreads based on a 3" Point Length

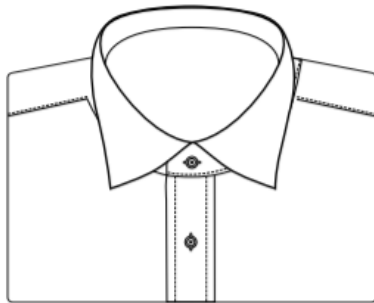

Curve Spread
CS-1

--



Narrow Curve Spread
NCS

--

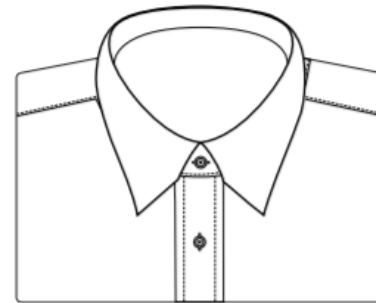

Mitered Spread**
MS-1

--

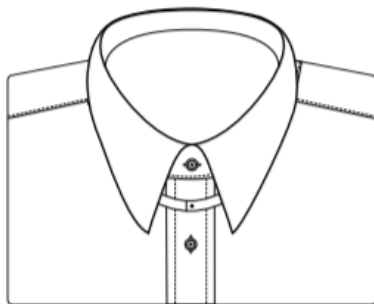

Tab Collar (Snap Fastener)
TC-1

2 1/2" Spread

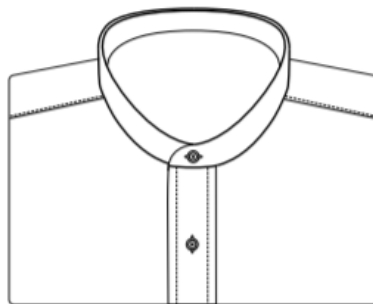

Band Collar*
BC-1

--

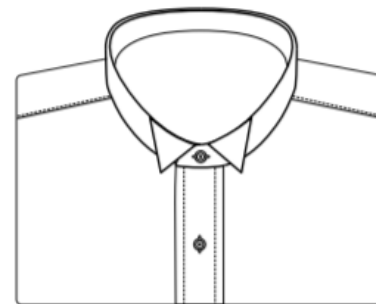

Wing Collar*
WC-1

--

Cuffs

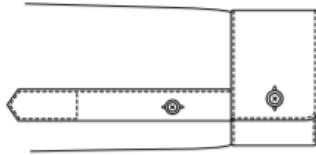

One Button Barrel

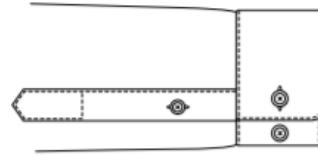

One Button Barrel (Adjustable)

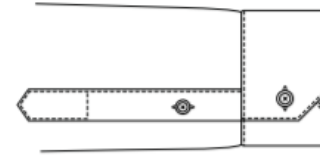

One Button Mitered

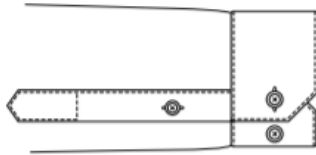

One Button Mitered (Adjustable)

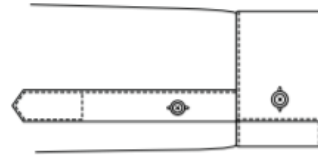

One Button Square

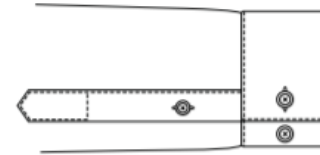

One Button Square (Adjustable)

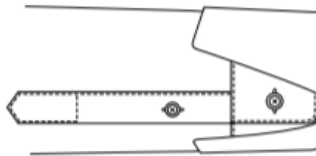

One Button Fold

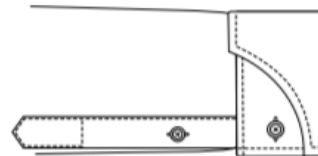

One Button Curved Fold

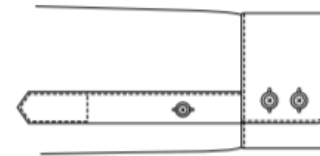

Two Button Barrel

Cuffs

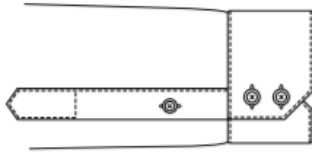

Two Button Mitered

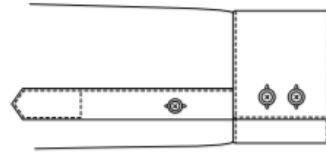

Two Button Square

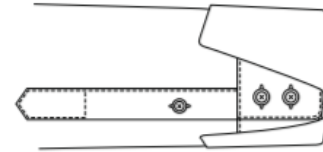

Two Button Fold

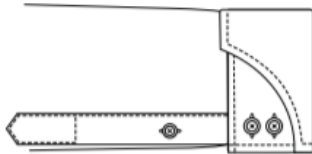

Two Button Curved Fold

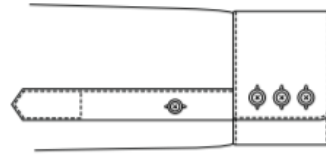

Three Button Barrel

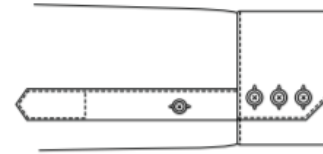

Three Button Mitered

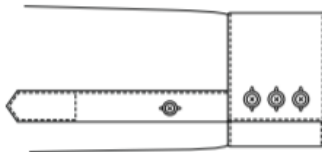

Three Button Square

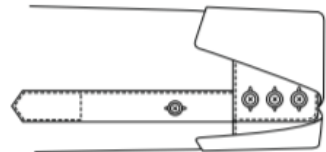

Three Button Fold

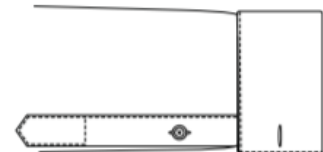

Classic French (Center)

Cuffs

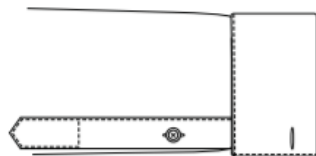

Classic French (Forward)

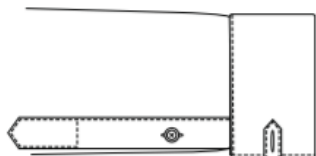

Classic French w/ Tab

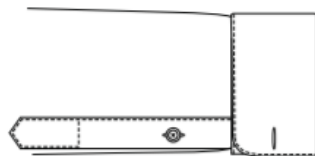

Rounded French (Center)

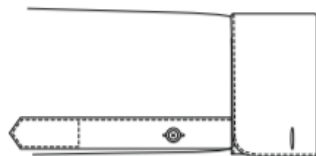

Rounded French (Forward)

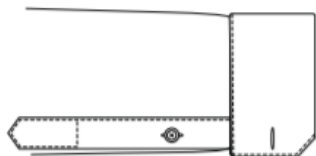

Angle Mitered French (Center)

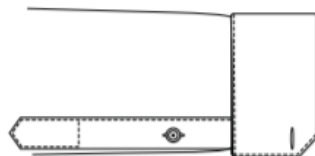

Angle Mitered French (Forward)

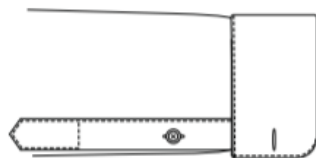

Round Mitered French (Center)

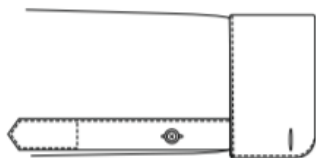

Round Mitered French (Forward)

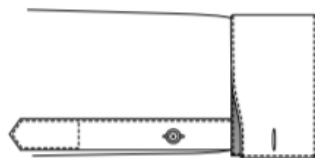

Scallop French (Center)

Cuffs

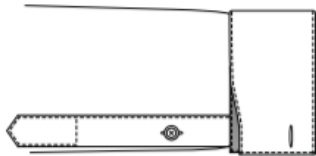

Scallop French (Forward)

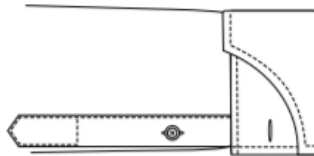

Curved Fold French (Center)

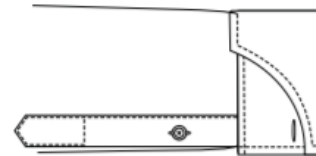

Curved Fold French (Forward)

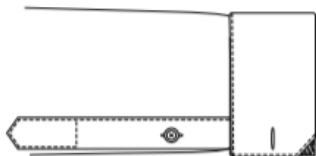

Window Angled French

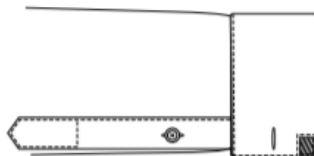

Window Square French

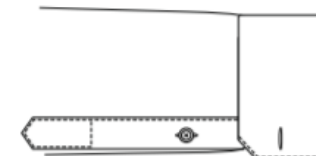

Rear Angle Mitered French

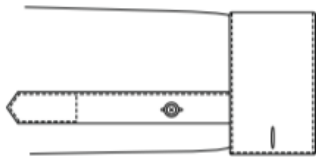

Non-Fold French

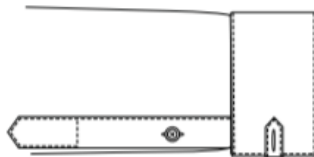

Non-Fold w/ Tab

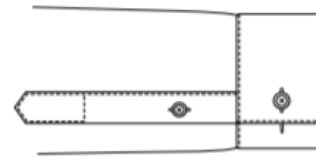

Non-Fold Convertible

Pocket Type

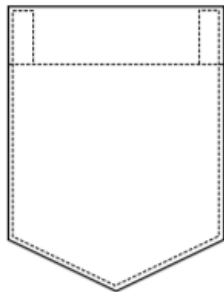

Plain

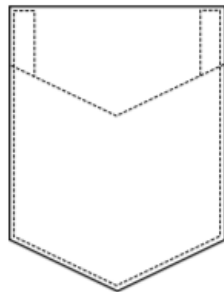

V Hem

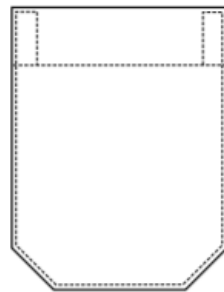

Mitered

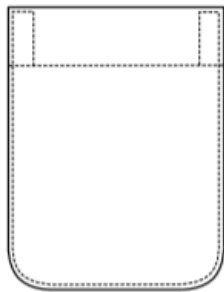

Rounded

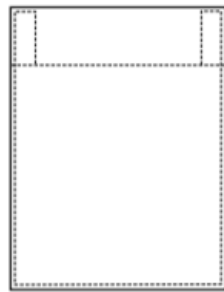

Square

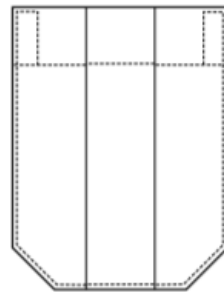

Pleated

Front Styles

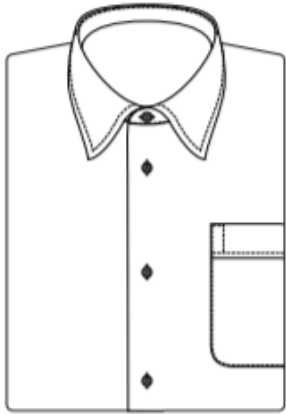

Plain

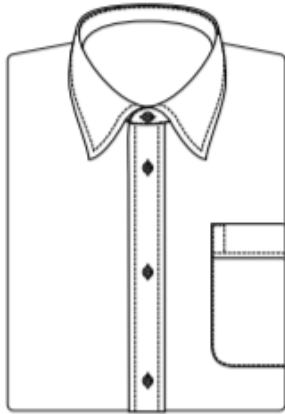

Placket

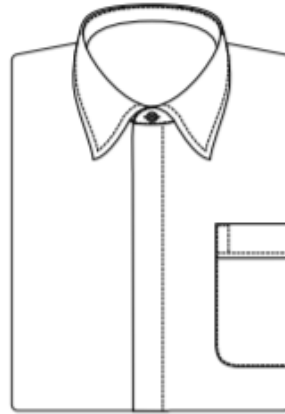

Fly Front Covered

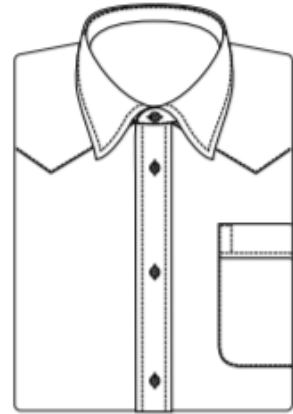

Western

Back Styles

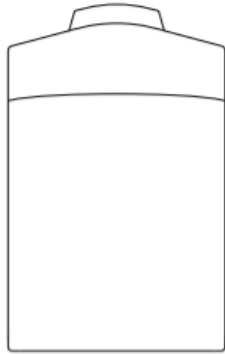

Plain

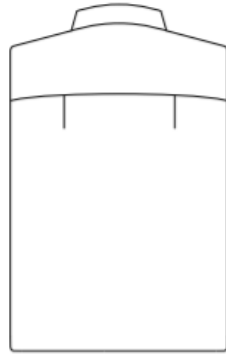

Shoulder Pleats

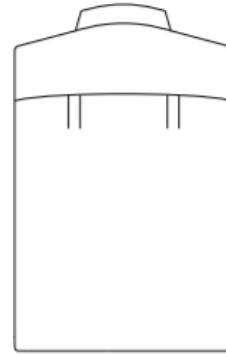

Double Shoulder Pleats

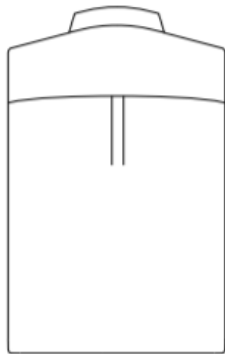

Center Box Pleat

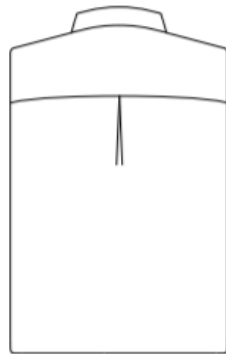

Inverted Center Box Pleat

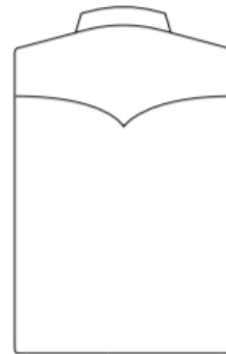

Western

Monogram Templates & Size



Diamond *



Diamond 1 Letter



Diamond 2 Letter



Diamond 3 Letter V2 *



Diamond 3 Letter V3 *



Diamond 3 Letter V4 *



Copper Plate 3 Letters *



Diagonal 2 Letters



Circle 1 Letter



Circle 2 Letters



Circle 3 Letters *



Stack 2 Letters



Varsity 1 Letter



Script 1 Letter



Script 2 Letters



Script 3 Letters *



Dotted Circle Letter



Crossroad Initials



Major League Initials *

Monogram Fonts

Caligraphy

ABCDEFGHIJKLMNOPQRSTUVWXYZ
 abcdefghijklmnopqrstuvwxyz
 1234567890?!&.,#@*~;:\$%()+

Times Roman

ABCDEFGHIJKLMNOPQRSTUVWXYZ
 abcdefghijklmnopqrstuvwxyz
 1234567890?!&.,#@*~;:\$%()+

Block

ABCDEFGHIJKLMNOPQRSTUVWXYZ
 abcdefghijklmnopqrstuvwxyz
 1234567890?!&.,#@*~;:\$%()+

Script

ABCDEFGHIJKLMNOPQRSTUVWXYZ
 abcdefghijklmnopqrstuvwxyz
 1234567890?!&.,#@*~;:\$%()+

Copper Plate

ABCDEFGHIJKLMNOPQRSTUVWXYZ
 1234567890?!&.,#@*~;:\$%()+

Rockwell

ABCDEFGHIJKLMNOPQRSTUVWXYZ
 abcdefghijklmnopqrstuvwxyz
 1234567890?!&.,#@*~;:\$%()+

Bradley

ABCDEFGHIJKLMNOPQRSTUVWXYZ
 abcdefghijklmnopqrstuvwxyz
 1234567890?!&.,#@*~;:\$%()+

Jazz

ABCDEFGHIJKLMNOPQRSTUVWXYZ
 abcdefghijklmnopqrstuvwxyz
 1234567890?!&.,#@*~;:\$%()+

Dom Casual

ABCDEFGHIJKLMNOPQRSTUVWXYZ
 abcdefghijklmnopqrstuvwxyz
 1234567890?!&.,#@*~;:\$%()+

Outline

ABCDEFGHIJKLMNOPQRSTUVWXYZ
 1234567890?!&.,#@*~;:\$%()+